

Simon Fraser University

Mechatronic Systems Engineering

Midterm Exam for ENSC 226: Electronic Circuits

Instructor: Behraad Bahreyni

23 February 2012

Time: 110 minutes

Name: _____

Student number: _____

Question	Mark
1	/ 10
2	/ 15
3	/ 20
4	/ 15
5	/ 30
Total	/ 90



Name: _____

Student number: _____

Midterm exam

Time: 110 minutes

February 23, 2012

Page: 2/10

USE PROPER MODELS FOR DEVICES BASED ON THE INFORMATION AVAILABLE TO YOU FOR THAT PARTICULAR PROBLEM. JUSTIFY ANY ASSUMPTION YOU MAKE.

$$\alpha = \frac{\beta}{\beta + 1} \qquad r_d = \frac{V_T}{I_D} \qquad V_T = 25mV$$

$$g_m = \frac{1}{r_m} = \frac{I_C}{V_T} \qquad r_\pi = \beta r_m = \frac{\beta}{g_m} \qquad r_o = \frac{V_A}{I_C}$$

Physical model of a diode: $I_D = I_s \left(e^{\frac{V_D}{V_T}} - 1 \right)$

Ripple voltage in half wave rectifiers: $V_r = \frac{V_P - V_{D,on}}{f R_L C_L}$

	Active	Saturation	Cut-off
	BE forward biased BC reverse biased	BE forward biased BC forward biased	BE reverse biased BC reverse biased
npn	$V_{BE} \approx 0.7V$ $V_{BC} < 0$ $I_C = \beta I_B = \alpha I_E$ $I_C = I_s e^{\frac{V_{BE}}{V_T}} \left(1 + \frac{V_{CE}}{V_A} \right)$	$V_{BE} \approx 0.7V$ $V_{BC} \approx 0.5V$ $I_B > \frac{I_C}{\beta}$ $V_{CE} \approx 0.2V$	$V_{BE} < 0.7$ $V_{BC} < 0.7$ $I_B \approx I_C \approx I_E \approx 0$
pnp	$V_{EB} \approx 0.7V$ $V_{CB} < 0$ $I_C = \beta I_B = \alpha I_E$ $I_C = I_s e^{\frac{V_{EB}}{V_T}} \left(1 + \frac{V_{EC}}{V_A} \right)$	$V_{EB} \approx 0.7V$ $V_{CB} \approx 0.5V$ $I_B > \frac{I_C}{\beta}$ $V_{EC} \approx 0.2V$	$V_{EB} < 0.7$ $V_{CB} < 0.7$ $I_B \approx I_C \approx I_E \approx 0$

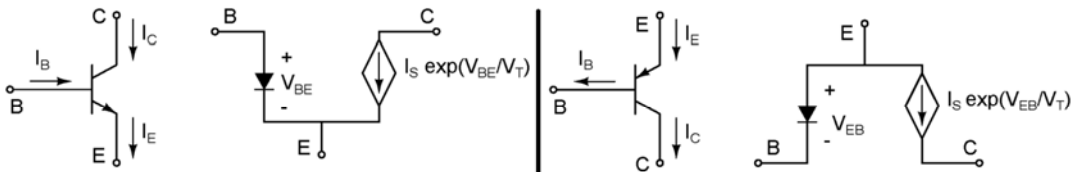

Name: _____ Student number: _____

Midterm exam Time: 110 minutes February 23, 2012 Page: 3/10

Question 1. [10 marks]

I.a. [6 marks] In Lab 2 you tested a transistor whose collector and emitter pins were switched in the circuit. Which transistor parameter was mostly affected by this?

What was the conclusion from that experiment?

I.b. [4 marks] Assume that you are given a working BJT whose model number has been erased from its package. We want to use a multimeter similar to the one you used in the lab to determine the type (npn or pnp) and pins (base, collector, and emitter) of the transistor. Using the diode more on the multimeter, the following data is obtained:

Between pins 2&1: $0.5V$ Between pins 1&2: *OPEN*Between pins 3&1: $0.7V$ Between pins 1&3: *OPEN*Between pins 2&3: *OPEN*Between pins 3&2: *OPEN*

where, for example, the measurement between pins 1&2 is taken by connecting the positive lead of the multimeter to pin 1 and its negative lead to pin 2. What are the type and pin arrangement of this transistor? Circle the correct answer.

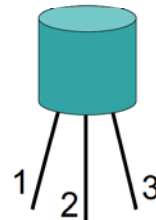

(a) npn; pin 1: Base, pin 2: Emitter, pin 3: Collector

(b) npn; pin 1: Base, pin 2: Collector, pin 3: Emitter

(c) pnp; pin 1: Base, pin 2: Emitter, pin 3: Collector

(d) pnp; pin 1: Base, pin 2: Collector, pin 3: Emitter

(e) None of the above

Name: _____

Student number: _____

Midterm exam

Time: 110 minutes

February 23, 2012

Page: 4/10

Question 2. [15 marks]

Assume $I_S = 10^{-12} A$ for the diode in the circuit to the right. v_{ac} is a small-signal source and $v_{ac} = 0.01 \sin \omega t$. All resistors are the same with a value of $R = 500 \Omega$ and $V_{DC} = +6V$.

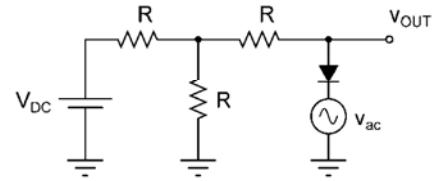

2.a. [9 marks] What is the DC voltage at the output node with an error of less than 0.005V?

$V_{OUT} =$ _____ V

2.b. [6 marks] What is the amplitude of the small-signal output voltage at the output node?

$v_{out} =$ _____ * $\sin \omega t$

Name: _____

Student number: _____

Midterm exam

Time: 110 minutes

February 23, 2012

Page: 5/10

Question 3. [20 marks]

Using the constant voltage drop model for the diodes, draw the input-output voltage characteristic curve for $-10V < V_{IN} < +10V$ for the circuit shown.

Clearly mention the state of all diodes for any voltage range in your analysis and label all important information on your graph (next page).

Assume $V_D(on) = 0.7V$, $R_1 = R_2 = R_3 = 1k\Omega$, and $V_B = +3V$.

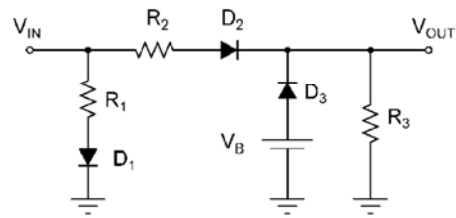

Name: _____

Student number: _____

Midterm exam

Time: 110 minutes

February 23, 2012

Page: 6/10

Question 3; cont.

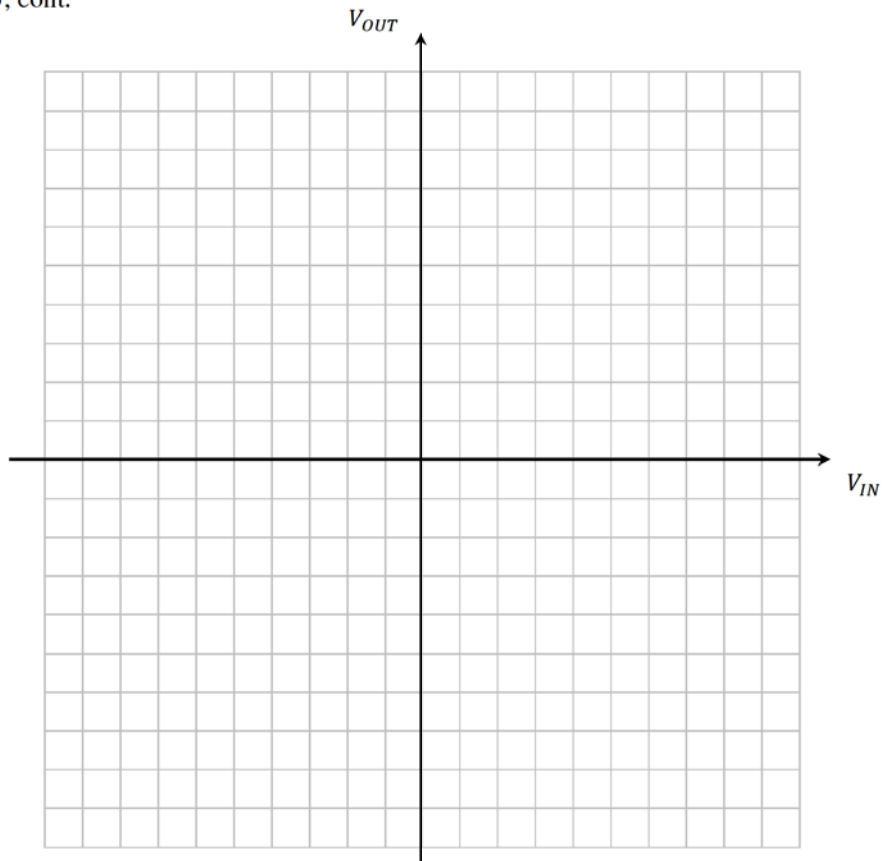

Name: _____ Student number: _____

Midterm exam Time: 110 minutes February 23, 2012 Page: 7/10

Question 4. [15 marks]

Consider the circuit shown to the right where $R_C = 2k\Omega$ and $R_B = 13k\Omega$. The transistor parameters are $V_{BE}(on) = 0.7V$, $V_{CE}(sat) = 0.2V$, $\beta = 100$, and $V_A = \infty$. Justify any assumptions you make.

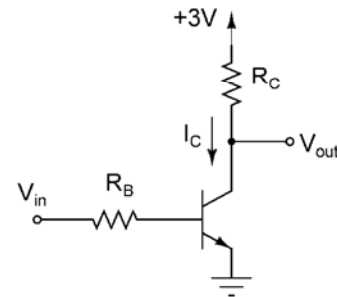

4.a. What is the operating region of the transistor if $V_{in} = 0V$?

What is the collector current, I_C ?

Operating region: _____

$I_C =$ _____ mA

4.b. What is the operating region of the transistor if $V_{in} = +2V$? What is I_C in this case?

Operating region: _____

$I_C =$ _____ mA

Name: _____ Student number: _____

Midterm exam Time: 110 minutes February 23, 2012 Page: 8/10

Question 5. [30 marks]

Consider the circuit shown to the right where the transistor is operating in its active region. Both capacitors can be considered as open-circuits for the DC analysis and as short-circuits for the AC analysis.

Parameters for the pnp transistor are: $\beta = 100$, $V_A = \infty$, $V_{EB}(on) = 0.7V$.

Assume: $V_{CC} = +3V$, $R_C = 2k\Omega$ and $R_{B1} = R_{B2} = 20k\Omega$.

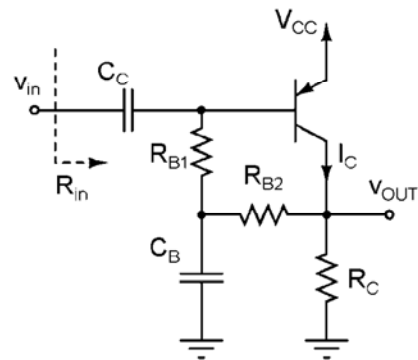

5.a. [8 marks] Calculate the collector current of the transistor.

$$I_C = \text{_____ mA}$$

5.b. [2 marks] What is the DC collector voltage of the transistor?

$$V_{OUT} = \text{_____ V}$$

Name: _____ Student number: _____

Midterm exam Time: 110 minutes February 23, 2012 Page: 9/10

5.c. [2 marks] Calculate the small signal parameters g_m and r_π .

$$g_m = \text{_____ mS}$$

$$r_\pi = \text{_____ k}\Omega$$

5.d. [4 marks] Draw the small signal equivalent of the circuit.

5.e. [6 marks] What is the voltage gain of the circuit?

$$A_v = \frac{v_{out}}{v_{in}} = \text{_____ V/V}$$

Name: _____

Student number: _____

Midterm exam

Time: 110 minutes

February 23, 2012

Page: 10/10

5.f. [8 marks] What is the input resistance of the circuit (R_{in} on the graph)?

$R_{in} =$ _____ $k\Omega$